



**LUBE**  
Control

Lube Control Pty Ltd



# OTSB TANKS & DISPENSE PACKAGES

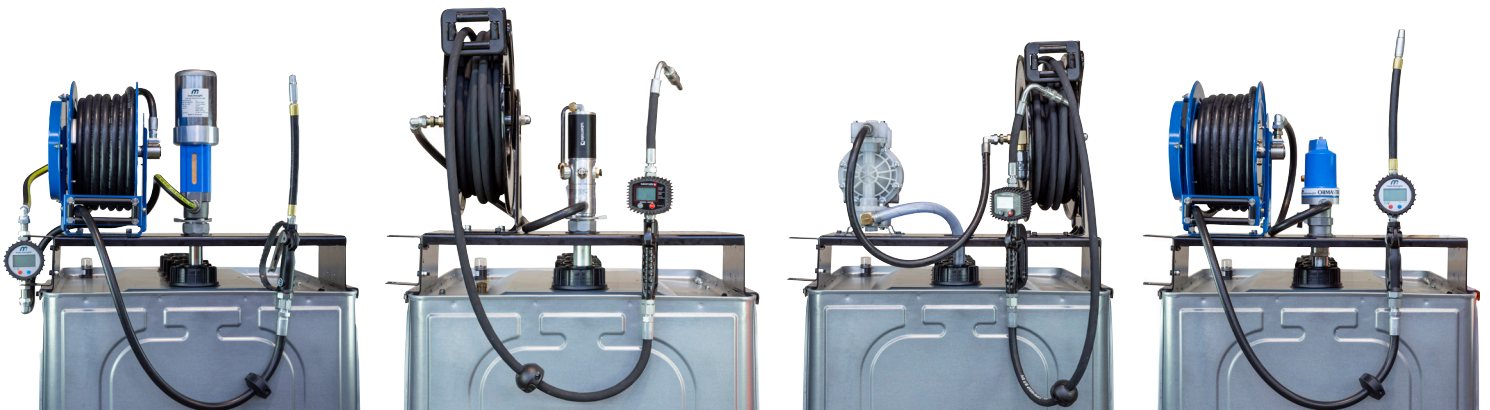

## OTSB TANKS & DISPENSE PACKAGES



The OTSB inner tank is manufactured from high molecular HDPE, with the outer tank constructed from galvanised sheet metal. The outer tank functions as a collecting tray and has the capacity to hold the full volume of the inner tank.

The tank design is suitable for the storage of a single fluid and can be used for the storage of many fluids such as Lubricating oils, heat transfer oils, mineral oils, hydraulic oils, fatty oils, fuel oil, diesel in the private, industrial and commercial sector. Integrated handles enable easy handling of the tank. The low centre of gravity provides a high degree of static stability. These tanks are compact and available in different sizes (400L/750L/1000L/1500L) providing more flexibility for placement in any workshop.



### ORDERING INFORMATION (TANK ONLY)

PART NUMBER	CAPACITY	L X W X H	WEIGHT
OTSB400	400L	740 X 700 X 1170mm	58Kg
OTSB750	750L	980 X 760 X 1420mm	81Kg
OTSB1000	1000L	1280 X 760 X 1420mm	104Kg
OTSB1500	1500L	1630 X 760 X 1860mm	160Kg

## Macnaught OTSB Tank Packages

Providing a complete solution from small to heavy duty fluid dispensing applications. The Macnaught OTSB Tank packages are built or configured exclusively for Macnaught branded equipment. The package and includes either a R-Series or T-Series pump, sturdy mounting bracket, and various equipment options to choose such as heavy-duty Oil Reel, In-line Meter, Metered or Unmetered oil gun. The packages will be shipped with all the necessary components and accessories to build a complete storage and dispensing system.

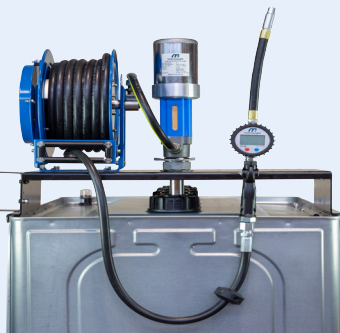

### OTS1215-R5E

- 5:1 R-Series Ratio Pump, 1/2" x 15m Oil Reel, Metered oil gun and mounting bracket.



### OTS1215-T5IM

- 5:1 T-Series Ratio Pump, 1/2"x15m Oil Reel, Unmetered gun, inline meter, and mounting bracket.



### OTS-R5

- 5:1 R-Series Ratio Pump, Unmetered oil gun, 6m hose and mounting bracket.

## MACNAUGHT OTSB TANK PACKAGES

SUITABLE MODELS FOR 400L TANK			
Part no (w/o tank)	Macnaught Oil Pump	Twin Pedestal Macnaught Reel	Oil Control Gun & In-line Meter
OTS1215-R5E	5:1 R-Series	1/2" x 15m Reel	Metered
OTS1215-R5	5:1 R-Series	1/2" x 15m Reel	Un-Metered
OTS1215-R5IM	5:1 R-Series	1/2" x 15m Reel	Un-Metered & In-line Meter
OTS-R5E	5:1 R-Series	X	Metered
OTS-R5	5:1 R-Series	X	Un-Metered
OTS-R5IM	5:1 R-Series	X	Un-Metered & In-line Meter
OTS1215-T5E	5:1 T-Series	1/2" x 15m Reel	Metered
OTS1215-T5	5:1 T-Series	1/2" x 15m Reel	Un-Metered
OTS1215-T5IM	5:1 T-Series	1/2" x 15m Reel	Un-Metered & In-line Meter
OTS-T5E	5:1 T-Series	X	Metered
OTS-T5	5:1 T-Series	X	Un-Metered
OTS-T5IM	5:1 T-Series	X	Un-Metered & In-line Meter

SUITABLE MODELS FOR 750L, 1000L AND 1500L TANKS			
Part no (w/o tank)	Macnaught Oil Pump	Twin Pedestal Macnaught Reel	Oil Control Gun & In-line Meter
OTL1215-R5E	5:1 R-Series	1/2" x 15m Reel	Metered
OTL1215-R5	5:1 R-Series	1/2" x 15m Reel	Un-Metered
OTL1215-R5IM	5:1 R-Series	1/2" x 15m Reel	Un-Metered & In-line Meter
OTL-R5E	5:1 R-Series	X	Metered
OTL-R5	5:1 R-Series	X	Un-Metered
OTL-R5IM	5:1 R-Series	X	Un-Metered & In-line Meter
OTL1215-T5E	5:1 T-Series	1/2" x 15m Reel	Metered
OTL1215-T5	5:1 T-Series	1/2" x 15m Reel	Un-Metered
OTL1215-T5IM	5:1 T-Series	1/2" x 15m Reel	Un-Metered & In-line Meter
OTL-T5E	5:1 T-Series	X	Metered
OTL-T5	5:1 T-Series	X	Un-Metered
OTL-T5IM	5:1 T-Series	X	Un-Metered & In-line Meter

⚠ The above packages list comes with 4 tank options to choose – 400L, 750L, 1000L & 1500L. For complete Kit with the Tank, add the respective tank at the end of each part number. For eg., for a 400L tank with any of the above package just add 400L at the end – OTS1215-R5-400L. Similarly, for a 1000L tank package, it becomes OTL1215-T5E-1000L etc. (Please refer the last page for the complete list of tank package part numbers and also note that 1500L does not have inline meter options). If you already have the tank, just select one of the above kits based on the tank size.

✂ If your kit is not mentioned this document, you can make your own kit in 5 easy steps, see below guidelines.

## MAKE YOUR OWN KIT - RECOMMENDED PRODUCTS

<p><b>Choose a tank:</b> OTSB400L, OTSB750L, OTSB1000L, OTSB1500L.</p> 	<p><b>Choose a bracket:</b> "IBC031" for 400L, &amp; "IBC030" for 750L, 1000L, 1500L.</p> 	<p><b>Options to choose from:</b> R-Series and T-Series 3:1 ratio pump. (R300S-01 / T312S-01)</p> 	<p><b>Optional Reels* –</b> MOTP1220-01 (1/2"x 20m) – twin pedestal MOS1220-01 (1/2"x 20m) – single pedestal</p> 	<p><b>Optional Oil Guns</b> "HG20R-01" Unmetered &amp; Rigid "HG20R-01 2E-01" Metered &amp; Rigid "HG55-01" Digital Metered Gun "HG60-01" Preset Digital Metered gun</p> 
---	---	---	---	--

\*Additional drills will be needed on the mounting bracket if reels are chosen separately and "tie-down" kits might be required for better stability based on the reel chosen. Hoses and accessories will need to be selected separately.

## Lubemate OTSB Tank Packages

Provide a complete solution from small to heavy duty dispense applications. The Lubemate Tank packages are built or configured exclusively with Lubemate branded equipment's to suit multiple applications. The package includes a 5:1 ratio pump, sturdy mounting bracket, and options to choose such as In-line Meter, Metered or Unmetered oil gun. The packages will be shipped with all the necessary components and accessories to build a complete storage and dispensing system.

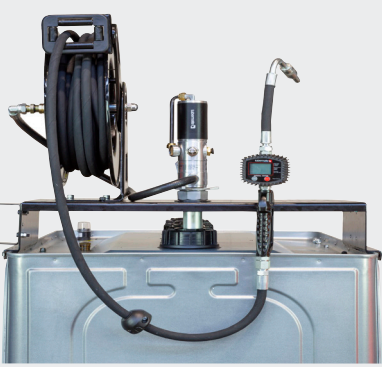

**OTS1215-L5E**

- Lubemate 5:1 Ratio Pump, 1/2"x15m Oil Reel, Metered oil gun and mounting bracket.

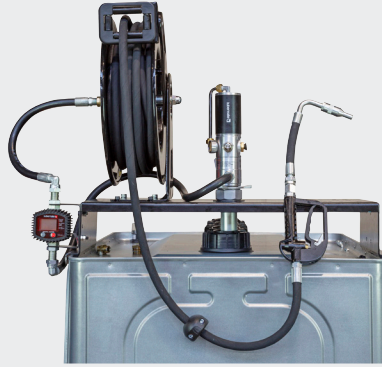

**OTS1215-L5IM**

- Lubemate 5:1 Ratio Pump, 1/2"x15m Oil Reel, Unmetered gun, inline meter, and mounting bracket.



**OTS-L5E**

- Lubemate 5:1 Ratio Pump, Unmetered oil gun, 6m hose and mounting bracket.

### LUBEMATE™ OTSB TANK PACKAGES

SUITABLE MODELS FOR 400L TANK			
Part no (w/o tank)	Lubemate Oil Pump	Single Pedestal Lubemate Reel	Oil Control Gun & In-line Meter
OTS1215-L5E	5:1 Stub	1/2" x 15m Reel	Metered
OTS1215-L5	5:1 Stub	1/2" x 15m Reel	Un-Metered
OTS1215-L5IM	5:1 Stub	1/2" x 15m Reel	Un-Metered & In-line Meter
OTS-L5E	5:1 Stub	X	Metered
OTS-L5	5:1 Stub	X	Un-Metered
OTS-L5IM	5:1 Stub	X	Un-Metered & In-line Meter

SUITABLE MODELS FOR 750L, 1000L AND 1500L TANKS			
Part no (w/o tank)	Lubemate Oil Pump	Single Pedestal Lubemate Reel	Oil Control Gun & In-line Meter
OTL1215-L5E	5:1 Stub	1/2" x 15m Reel	Metered
OTL1215-L5	5:1 Stub	1/2" x 15m Reel	Un-Metered
OTL1215-L5IM	5:1 Stub	1/2" x 15m Reel	Un-Metered & In-line Meter
OTL-L5E	5:1 Stub	X	Metered
OTL-L5	5:1 Stub	X	Un-Metered
OTL-L5IM	5:1 Stub	X	Un-Metered & In-line Meter

! The above packages list comes with 4 tank options to choose – 400L, 750L, 1000L & 1500L. For complete Kit with the Tank, add the respective tank at the end of each part number. For eg., for a 400L tank with any of the above package just add 400L at the end – OTS1215-L5E-400L. Similarly, for a 1000L tank package, it becomes OTL-L5-1000L etc. (Please refer the last page for the complete list of tank package part numbers and also note that 1500L tank does not have inline meter options). If you already have the tank, just select one of the above kits based on the Tank size.

✂ If your kit is not mentioned this document, you can make your own kit in 5 easy steps, see below guidelines.

### MAKE YOUR OWN KIT - RECOMMENDED PRODUCTS

**Choose a tank:**  
OTSB400L, OTSB750L,  
OTSB1000L, OTSB1500L.



**Choose a bracket:**  
"IBC031" for 400L, &  
"IBC030" for 750L,  
1000L, 1500L.



**Other Optional Reel\*:**  
L-OTP1215-01(1/2"x 15m)  
twin pedestal



**Optional Oil Guns**  
"L-DOGRM" Metered, Rigid, Manual Gun  
"L-OGRM" Unmetered, Rigid and manual gun  
"L-MOGF" Metered, Flexible, Manual Gun  
"TD-01" Unmetered, Rigid and manual gun  
"L-DPOCG" Preset Digital Metered gun



\*Additional drills will be needed on the mounting bracket if reels are chosen separately and "tie-down" kits might be required for better stability based on the reel chosen. Hoses and accessories will need to be selected separately.

## OTSB Tank Anti-Freeze Packages

Provide a complete solution which includes an air operated diaphragm pump (1/2"), sturdy mounting bracket, and various equipment options to choose like the Reel, Metered or Unmetered gun. The packages will be shipped with all the necessary components and accessories to build a complete storage and dispensing system.

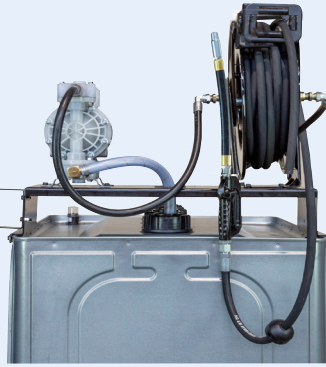

**OTS1215-DP13AF**

- Air operated Diaphragm pump L-DDP13 (1/2"), 1/2"x15m Reel, unmetered gun and mounting bracket.

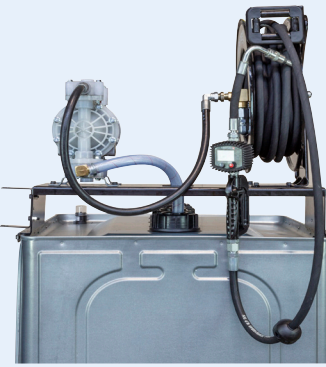

**OTS1215-DP13AFE**

- Air operated Diaphragm pump L-DDP13 (1/2"), 1/2"x15m Reel, metered gun and mounting bracket.



**OTS-DP13AF**

- Air operated Diaphragm pump L-DDP13 (1/2"), unmetered gun and mounting bracket.

### OTSB TANK ANTI-FREEZE PACKAGES

SUITABLE MODELS FOR 400L TANK			
Part no (w/o tank)	Diaphragm Pump	Single Pedestal Lubemate Reel	Control Gun
OTS1215-DP13AF	1/2" DDP	1/2" x 15m Reel	Un-Metered
OTS1215-DP13AFE	1/2" DDP	1/2" x 15m Reel	Metered
OTS-DP13AF	1/2" DDP	X	Un-Metered
OTS-DP13AFE	1/2" DDP	X	Metered

SUITABLE MODELS FOR 750L, 1000L AND 1500L TANKS			
Part no (w/o tank)	Diaphragm Pump	Single Pedestal Lubemate Reel	Control Gun
OTL1215-DP13AF	1/2" DDP	1/2" x 15m Reel	Un-Metered
OTL1215-DP13AFE	1/2" DDP	1/2" x 15m Reel	Metered
OTL-DP13AF	1/2" DDP	X	Un-Metered
OTL-DP13AFE	1/2" DDP	X	Metered

**!** The above packages list comes with 4 tank options to choose - 400L, 750L, 1000L & 1500L. For complete Kit with the Tank, add the respective tank at the end of each part number. For eg., for a 400L tank with any of the above package just add 400L at the end - OTS1215-DP13AF-400L. Similarly, for a 1000L tank package, it becomes OTL-DP13AF-1000L etc. (Also refer the last page for the complete list of tank package part numbers). If you already have the tank, just select one of the above kits based on the Tank size.

## OTSB Tank Waste Fluid Package

Provide a complete solution which includes an air operated diaphragm pump (1/2"), sturdy mounting bracket, 4-way valve and all the necessary components and accessories to build a complete storage and dispensing system.

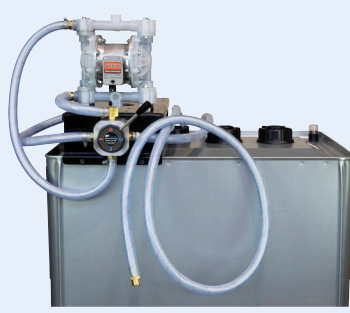

**OTS-DP194W**

- Air operated Diaphragm pump L-DDP19 (3/4"), 4-way valve (M4WV19) and mounting bracket.

### OTSB TANK WASTE FLUID PACKAGES

SUITABLE MODELS FOR 400L TANK		
Part no (w/o tank)	Diaphragm Pump	4 Way Valve
OTS-DP194W	3/4" DDP	3/4"

SUITABLE MODELS FOR 750L, 1000L AND 1500L TANKS		
Part no (w/o tank)	Diaphragm Pump	4 Way Valve
OTL-DP194W	3/4" DDP	3/4"

**!** The above packages list comes with 4 tank options to choose - 400L, 750L, 1000L & 1500L. For complete Kit with the Tank, add the respective tank at the end of each part number. For eg., for a 400L tank with the above package just add 400L at the end - OTS-DP194W-400L. Similarly, for a 1000L tank package, it becomes OTL-DP194W-1000L etc. (Also refer the last page for the complete list of tank package part numbers). If you already have the tank, just select the above kit and the respective mounting bracket ("IBC031" for 400L & "IBC030" for 750,1000, 1500L) based on the Tank size.

## TIE DOWN KIT (ACCESSORY)

Tie down kits are used as an aid to keep the tanks from shifting, tipping over or floating off the base and these kits will be needed to secure and tighten the OTSB Tanks in low and high-risk areas. In areas for example where a threat of flooding or high winds exists, or in basements with a history of flooding, use of tie-down kits is recommended. In areas of known earthquake activity, consult local codes for required restraint systems. In both cases, the steel foundation and related structures must be capable of keeping the tank anchored in place.

Each tie down kit consists of lashing strap with hooks on both ends and a push through anchor with a ring nut. The Kit includes two tie downs, one for each side of the tank. Be sure tank remains level during and after tightening the tie down kits. Use one kit (2 x tie downs) in low-risk areas and multiple kits in high-risk areas especially with the 1000L & 1500L tanks.

### SUITABLE FOR ALL OTSB TANKS

Part no	Description
IBC036	OTSB Tank TIE DOWN KIT

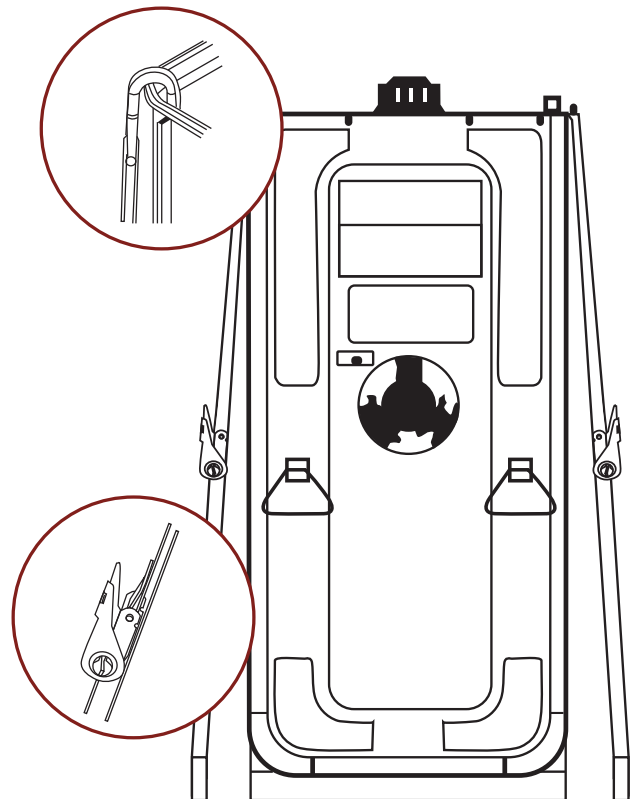

## List of all OTSB Tank Packages

(includes mounting bracket, hoses and all components)

	Part Number (with Tank)	Tank P/n	Part No. (w/o Tank)	Pump	Hose Reel	Gun/Meter/4 Way Valve
<b>400L TANK</b>	OTS1215-R5-400L	OTSB400	OTS1215-R5	5:1 R-Series	1/2"x15m (MAC)	Metered Gun
	OTS1215-R5E-400L	OTSB400	OTS1215-R5E	5:1 R-Series	1/2"x15m (MAC)	Un-Metered Gun
	OTS1215-R5IM-400L	OTSB400	OTS1215-R5IM	5:1 R-Series	1/2"x15m (MAC)	Un-Metered Gun & In-line Meter
	OTS1215-T5-400L	OTSB400	OTS1215-T5	5:1 T-Series	1/2"x15m (MAC)	Metered Gun
	OTS1215-T5E-400L	OTSB400	OTS1215-T5E	5:1 T-Series	1/2"x15m (MAC)	Un-Metered Gun
	OTS1215-T5IM-400L	OTSB400	OTS1215-T5IM	5:1 T-Series	1/2"x15m (MAC)	Un-Metered Gun & In-line Meter
	OTS-R5-400L	OTSB400	OTS-R5	5:1 R-Series	X	Metered Gun
	OTS-R5E-400L	OTSB400	OTS-R5E	5:1 R-Series	X	Un-Metered Gun
	OTS-R5IM-400L	OTSB400	OTS-R5IM	5:1 R-Series	X	Un-Metered Gun & In-line Meter
	OTS-T5-400L	OTSB400	OTS-T5	5:1 T-Series	X	Metered Gun
	OTS-T5E-400L	OTSB400	OTS-T5E	5:1 T-Series	X	Un-Metered Gun
	OTS-T5IM-400L	OTSB400	OTS-T5IM	5:1 T-Series	X	Un-Metered Gun & In-line Meter
	OTS1215-L5-400L	OTSB400	OTS1215-L5	5:1 Stub	1/2"x15m (LM)	Metered Gun
	OTS1215-L5E-400L	OTSB400	OTS1215-L5E	5:1 Stub	1/2"x15m (LM)	Un-Metered Gun
	OTS1215-L5IM-400L	OTSB400	OTS1215-L5IM	5:1 Stub	1/2"x15m (LM)	Un-Metered Gun & In-line Meter
	OTS-L5-400L	OTSB400	OTS-L5	5:1 Stub	X	Metered Gun
	OTS-L5E-400L	OTSB400	OTS-L5E	5:1 Stub	X	Un-Metered Gun
	OTS-L5IM-400L	OTSB400	OTS-L5IM	5:1 Stub	X	Un-Metered Gun & In-line Meter
	OTS-DP194W-400L	OTSB400	OTS-DP194W	3/4" DDP	X	3/4" 4 Way Valve
	OTS1215-DP13AF-400L	OTSB400	OTS1215-DP13AF	1/2" DDP	1/2"x15m (LM)	Metered Gun
	OTS1215-DP13AFE-400L	OTSB400	OTS1215-DP13AFE	1/2" DDP	1/2"x15m (LM)	Un-Metered Gun
	OTS-DP13AF-400L	OTSB400	OTS-DP13AF	1/2" DDP	X	Metered Gun
	OTS-DP13AFE-400L	OTSB400	OTS-DP13AFE	1/2" DDP	X	Un-Metered Gun
	<b>750L TANK</b>	OTL1215-R5-750L	OTSB750	OTL1215-R5	5:1 R-Series	1/2"x15m (MAC)
OTL1215-R5E-750L		OTSB750	OTL1215-R5E	5:1 R-Series	1/2"x15m (MAC)	Un-Metered Gun
OTL1215-R5IM-750L		OTSB750	OTL1215-R5IM	5:1 R-Series	1/2"x15m (MAC)	Un-Metered Gun & In-line Meter
OTL1215-T5-750L		OTSB750	OTL1215-T5	5:1 T-Series	1/2"x15m (MAC)	Metered Gun
OTL1215-T5E-750L		OTSB750	OTL1215-T5E	5:1 T-Series	1/2"x15m (MAC)	Un-Metered Gun
OTL1215-T5IM-750L		OTSB750	OTL1215-T5IM	5:1 T-Series	1/2"x15m (MAC)	Un-Metered Gun & In-line Meter
OTL-R5-750L		OTSB750	OTL-R5	5:1 R-Series	X	Metered Gun
OTL-R5E-750L		OTSB750	OTL-R5E	5:1 R-Series	X	Un-Metered Gun
OTL-R5IM-750L		OTSB750	OTL-R5IM	5:1 R-Series	X	Un-Metered Gun & In-line Meter
OTL-T5-750L		OTSB750	OTL-T5	5:1 T-Series	X	Metered Gun
OTL-T5E-750L		OTSB750	OTL-T5E	5:1 T-Series	X	Un-Metered Gun
OTL-T5IM-750L		OTSB750	OTL-T5IM	5:1 T-Series	X	Un-Metered Gun & In-line Meter
OTL1215-L5-750L		OTSB750	OTL1215-L5	5:1 Stub	1/2"x15m (LM)	Metered Gun
OTL1215-L5E-750L		OTSB750	OTL1215-L5E	5:1 Stub	1/2"x15m (LM)	Un-Metered Gun
OTL1215-L5IM-750L		OTSB750	OTL1215-L5IM	5:1 Stub	1/2"x15m (LM)	Un-Metered Gun & In-line Meter
OTL-L5-750L		OTSB750	OTL-L5	5:1 Stub	X	Metered Gun
OTL-L5E-750L		OTSB750	OTL-L5E	5:1 Stub	X	Un-Metered Gun
OTL-L5IM-750L		OTSB750	OTL-L5IM	5:1 Stub	X	Un-Metered Gun & In-line Meter
OTL-DP194W-750L		OTSB750	OTL-DP194W	3/4" DDP	X	3/4" 4 Way Valve
OTL1215-DP13AF-750L		OTSB750	OTL1215-DP13AF	1/2" DDP	1/2"x15m (LM)	Metered Gun
OTL1215-DP13AFE-750L		OTSB750	OTL1215-DP13AFE	1/2" DDP	1/2"x15m (LM)	Un-Metered Gun
OTL-DP13AF-750L		OTSB750	OTL-DP13AF	1/2" DDP	X	Metered Gun
OTL-DP13AFE-750L		OTSB750	OTL-DP13AFE	1/2" DDP	X	Un-Metered Gun



## List of all OTSB Tank Packages

(includes mounting bracket, hoses and all components)

	Part Number (with Tank)	Tank P/n	Part No. (w/o Tank)	Pump	Hose Reel	Gun/Meter/4 Way Valve
<b>1000L TANK</b>	OTL1215-R5-1000L	OTSB1000	OTL1215-R5	5:1 R-Series	1/2"x15m (MAC)	Metered Gun
	OTL1215-R5E-1000L	OTSB1000	OTL1215-R5E	5:1 R-Series	1/2"x15m (MAC)	Un-Metered Gun
	OTL1215-R5IM-1000L	OTSB1000	OTL1215-R5IM	5:1 R-Series	1/2"x15m (MAC)	Un-Metered Gun & In-line Meter
	OTL1215-T5-1000L	OTSB1000	OTL1215-T5	5:1 T-Series	1/2"x15m (MAC)	Metered Gun
	OTL1215-T5E-1000L	OTSB1000	OTL1215-T5E	5:1 T-Series	1/2"x15m (MAC)	Un-Metered Gun
	OTL1215-T5IM-1000L	OTSB1000	OTL1215-T5IM	5:1 T-Series	1/2"x15m (MAC)	Un-Metered Gun & In-line Meter
	OTL-R5-1000L	OTSB1000	OTL-R5	5:1 R-Series	X	Metered Gun
	OTL-R5E-1000L	OTSB1000	OTL-R5E	5:1 R-Series	X	Un-Metered Gun
	OTL-R5IM-1000L	OTSB1000	OTL-R5IM	5:1 R-Series	X	Un-Metered Gun & In-line Meter
	OTL-T5-1000L	OTSB1000	OTL-T5	5:1 T-Series	X	Metered Gun
	OTL-T5E-1000L	OTSB1000	OTL-T5E	5:1 T-Series	X	Un-Metered Gun
	OTL-T5IM-1000L	OTSB1000	OTL-T5IM	5:1 T-Series	X	Un-Metered Gun & In-line Meter
	OTL1215-L5-1000L	OTSB1000	OTL1215-L5	5:1 Stub	1/2"x15m (LM)	Metered Gun
	OTL1215-L5E-1000L	OTSB1000	OTL1215-L5E	5:1 Stub	1/2"x15m (LM)	Un-Metered Gun
	OTL1215-L5IM-1000L	OTSB1000	OTL1215-L5IM	5:1 Stub	1/2"x15m (LM)	Un-Metered Gun & In-line Meter
	OTL-L5-1000L	OTSB1000	OTL-L5	5:1 Stub	X	Metered Gun
	OTL-L5E-1000L	OTSB1000	OTL-L5E	5:1 Stub	X	Un-Metered Gun
	OTL-L5IM-1000L	OTSB1000	OTL-L5IM	5:1 Stub	X	Un-Metered Gun & In-line Meter
	OTL-DP194W-1000L	OTSB1000	OTL-DP194W	3/4" DDP	X	3/4" 4 Way Valve
	OTL1215-DP13AF-1000L	OTSB1000	OTL1215-DP13AF	1/2" DDP	1/2"x15m (LM)	Metered Gun
OTL1215-DP13AFE-1000L	OTSB1000	OTL1215-DP13AFE	1/2" DDP	1/2"x15m (LM)	Un-Metered Gun	
OTL-DP13AF-1000L	OTSB1000	OTL-DP13AF	1/2" DDP	X	Metered Gun	
OTL-DP13AFE-1000L	OTSB1000	OTL-DP13AFE	1/2" DDP	X	Un-Metered Gun	
<b>1500L TANK</b>	OTL1215-R5-1500L	OTSB1500	OTL1215-R5	5:1 R-Series	1/2"x15m (MAC)	Metered Gun
	OTL1215-R5E-1500L	OTSB1500	OTL1215-R5E	5:1 R-Series	1/2"x15m (MAC)	Un-Metered Gun
	OTL1215-T5-1500L	OTSB1500	OTL1215-T5	5:1 T-Series	1/2"x15m (MAC)	Metered Gun
	OTL1215-T5E-1500L	OTSB1500	OTL1215-T5E	5:1 T-Series	1/2"x15m (MAC)	Un-Metered Gun
	OTL-R5-1500L	OTSB1500	OTL-R5	5:1 R-Series	X	Metered Gun
	OTL-R5E-1500L	OTSB1500	OTL-R5E	5:1 R-Series	X	Un-Metered Gun
	OTL-T5-1500L	OTSB1500	OTL-T5	5:1 T-Series	X	Metered Gun
	OTL-T5E-1500L	OTSB1500	OTL-T5E	5:1 T-Series	X	Un-Metered Gun
	OTL1215-L5-1500L	OTSB1500	OTL1215-L5	5:1 Stub	1/2"x15m (LM)	Metered Gun
	OTL1215-L5E-1500L	OTSB1500	OTL1215-L5E	5:1 Stub	1/2"x15m (LM)	Un-Metered Gun
	OTL-L5-1500L	OTSB1500	OTL-L5	5:1 Stub	X	Metered Gun
	OTL-L5E-1500L	OTSB1500	OTL-L5E	5:1 Stub	X	Un-Metered Gun
	OTL-DP194W-1500L	OTSB1500	OTL-DP194W	3/4" DDP	X	3/4" 4 Way Valve
	OTL1215-DP13AF-1500L	OTSB1500	OTL1215-DP13AF	1/2" DDP	1/2"x15m (LM)	Metered Gun
	OTL1215-DP13AFE-1500L	OTSB1500	OTL1215-DP13AFE	1/2" DDP	1/2"x15m (LM)	Un-Metered Gun
	OTL-DP13AF-1500L	OTSB1500	OTL-DP13AF	1/2" DDP	X	Metered Gun
	OTL-DP13AFE-1500L	OTSB1500	OTL-DP13AFE	1/2" DDP	X	Un-Metered Gun